

Polaris Booster Pump Installation Instructions

The Polaris booster pump supplies high pressure water to the Polaris pool cleaner to optimize cleaner efficiency. The pump is not self-priming and should only be used when the pool filtration pump is on. Running the booster pump without the filtration pump will damage the booster pump. Improper operation of the booster pump will void the warranty.

IMPORTANT SAFETY INFORMATION

When installing and using this electrical equipment basic safety precautions should be followed including the following:

READ AND FOLLOW ALL INSTRUCTIONS.

The electrical hook-up of the pump should be performed by a licensed electrician and conform to all national electric codes (NEC), state and local codes.

Use solid copper bonding conductor, no smaller than No. 8 AWG (8.4 mm²), 6 AWG (13.3 mm²) in Canada, to connect the motor to all metal parts of the pool, spa or hot tub structure, all electrical equipment, and all metal conduit and metal piping within 5 ft (1.5 m) of the inside walls of the swimming pool, spa or hot tub.

Use this pump only with permanently installed pools, and hot tubs and spas if so marked. A permanently installed pool is constructed in or on the ground or in a building, and cannot be easily disassembled and reassembled.

WARNING: To reduce the risk of injury, do not permit children to use this product unless they are closely supervised at all times.

SAVE THESE INSTRUCTIONS.

Installation

Electrical

The starting current of the booster pump motor may exceed 15 amps. It is recommended that a 20 amp service breaker be used for the pump.

The booster pump motor is factory wired for 240 volts, but can be wired for either 120 or 240 volts. To rewire to 120 volt, follow the instructions on the name plate located on the back of the motor or the sizing plate on the side of the motor.

A separate time clock (in addition to the filtration system time clock) is recommended to control the On/Off functions of the booster pump. A manual switch can also be used.

If a time clock is used, set it to turn the pump on half an hour after the pool filtration pump is turned on, and turn the pump off at least half an hour before the filtration pump shuts off. Periodically check the time clock settings to make sure they are properly synchronized.

Plumbing

The Polaris Booster Pump requires a dedicated return line. Plumb the booster pump into the system so that it always receives flow from the filtration pump.

To ensure proper function of the pump and the cleaner, refer to the Typical Installation diagram and adhere to the following guidelines for specific equipment.

- Plumb the dedicated line upstream of all air inducing equipment.
- If a heater is installed on the system, tap the inlet for the booster pump into the return line downstream and at least three feet from the heater discharge. Do not tap the booster pump inlet into the three-foot section of heat sink pipe that comes directly out of the heater.
- Some solar heating systems utilize the entire water flow when the panels are being purged of air. If the pump is installed in a non-flow pipe during solar panel purges, install an automatic override to shut off the pump.
- Plumb the booster pump inlet higher, upstream and as far away as possible from the chlorinator.

Typical Installation

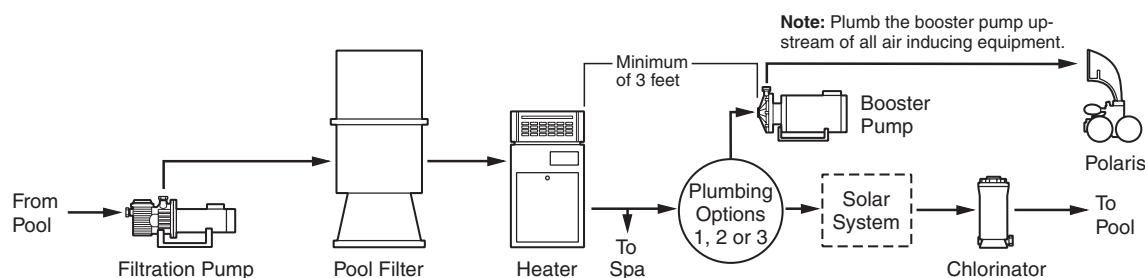

To ensure proper water flow:

- Use rigid PVC pipe with a minimum diameter of 3/4", 1-1/2" is recommended, for the dedicated return line. Flexible PVC piping is not recommended as it can be damaged by expansion and movement caused by the surge of pump pressure. Poly pipe is not recommended because it has clamps that can fail. Polaris is not responsible for damages caused by the use of such materials.
- The booster pump inlet connection line should be at least 3/4" pipe. The Softube® quick connect is designed to work with the Polaris reinforced hose (part #P19) only.
- Do not tap into the top of a horizontal line.
- Use 90° street ells to minimize bends and loops in the Polaris reinforced hose.

Recommended plumbing configurations.

Preferred Configuration

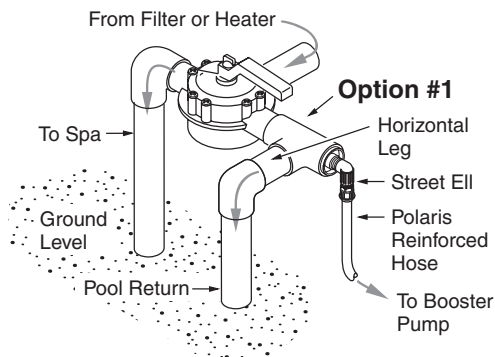

Alternative Configuration

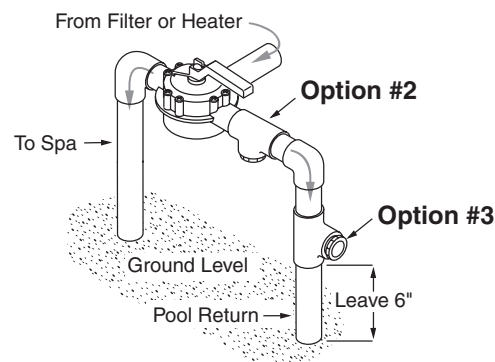

Installing the Pump

1. Mount the pump using four concrete expansion anchors to ensure stability.
2. If rotation (or removal) of volute is necessary:
 - Remove volute and clean RTV sealant from the sealing surfaces of all components.
 - Thoroughly dry components.
 - Apply a 1/8" bead of RTV sealant around the sealing surface of the volute approximately 1/4" from the inner diameter of the sealing area.
 - Reinstall the o-ring, without sealant.
 - Orient the volute as needed and reattach.
3. Slide the quick connect retainer ring over the Softube quick connect threads. Install quick connects onto pump discharge and supply ports using clear silicone as a thread sealant.
4. Measure and cut reinforced hose ensuring cut is clean, with no more than a 30° off straight edge. Avoid unnecessary loops or bends in the hose.
5. Push the hose onto the quick connect until it is flush against the hose barb base.

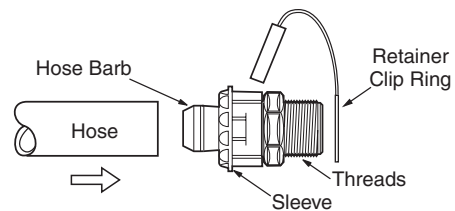

6. Holding the hose in place, pull and twist the sleeve on the quick connect over the hose as far as possible. Snap the clip into place.

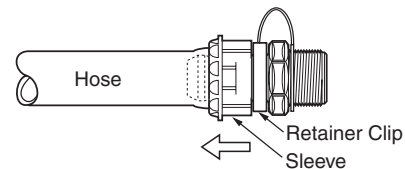

Checking Water Flow

After the system is plumbed, verify water flow to the booster pump by turning on the filtration pump and disconnecting the inlet supply line at the pump. Water should flow from the line.

If there is no flow:

- Verify that the installation is correct.
- Install a ball valve on the return line after the booster pump inlet.
- Use smaller eyeball fittings in the pool return lines or plug a return line.

Once flow is established, the pump is ready for operation.

Complete Installation

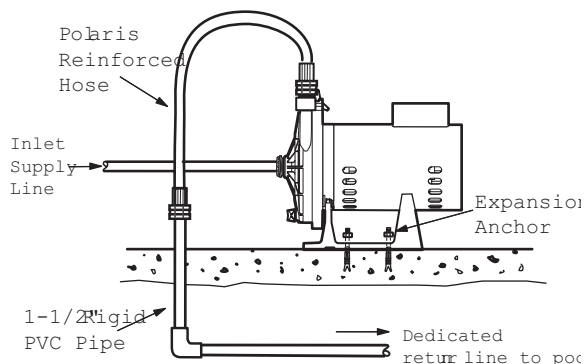

Winterizing

If installed in an area prone to freezing temperatures, the pump should be winterized to prevent freeze damage.

- Pull out drain plug and drain all water from pump.
- Disconnect plumbing hose at quick disconnects on pump inlet and outlet ports.

When reinstalling, recut the hose to eliminate crimps or bulges, and to ensure a straight edge before reconnecting the Softube quick connects.

Polaris Booster Pump Limited Warranty

This limited warranty is extended to the original consumer purchaser of this Polaris Booster Pump manufactured by Zodiac Pool Care, Inc. ("Zodiac"), 2620 Commerce Way, Vista, CA 92081-8438, USA.

Zodiac warrants the Booster Pump it manufactures, including all parts and components thereof, to be free of defects in material and workmanship. If you have a question regarding your Polaris Booster Pump, please feel free to call or write us. Be sure to include the serial number of your unit.

The warranty commences on the date of installation of the pump and shall remain in effect for a period of twelve months, but in no event shall it be in effect for more than twenty-four months from the date of manufacture of the pump as established by the serial number.

This limited warranty does not apply if the failure is caused or contributed by any of the following: improper handling, improper storage, abuse, unsuitable application of the unit, lack of reasonable and necessary maintenance, winter freezing or repairs made or attempted by other than Zodiac or one of its authorized service centers. Zodiac will repair or replace, at its option, a unit or part proved to be defective within the warranty period and under the conditions of the warranty.

Unless local repair is authorized, the consumer must deliver or ship the unit or the warranty parts, freight prepaid to the nearest Polaris Authorized Service Center or return it freight prepaid (after proper authorization) to the plant of manufacture. Authorization to return a unit to the plant of manufacture must be obtained from the Zodiac Customer Service Department. For your convenience, please check with your dealer for the local procedure before exercising this warranty. If further directions or instructions should be required, contact the Customer Service Department at 1-800-822-7933 (USA and Canada only). Be sure to insure your shipments against loss or damage in transit.

Zodiac is not responsible for the cost of removal of the unit, damages due to removal, any other expenses incurred in shipping the unit or parts to or from the factory or its authorized service centers, or the installation of the repaired or replacement unit. The consumer must bear these expenses.

This warranty does not cover repair or replacement of a unit except at our factory or a Polaris Authorized Service Center.

THIS LIMITED WARRANTY IS IN LIEU OF ALL OTHER WARRANTIES, EXPRESS OR IMPLIED, INCLUDING THE IMPLIED WARRANTIES OF MERCHANTABILITY AND FITNESS FOR A PARTICULAR PURPOSE, AND ALL SUCH OTHER WARRANTIES ARE DISCLAIMED EXCEPT TO THE EXTENT ANY IMPLIED WARRANTY MAY BE IMPOSED BY STATE CONSUMER LAW. ANY SUCH IMPLIED WARRANTY IMPOSED BY STATE CONSUMER LAW IS LIMITED IN DURATION TO ONE (1) YEAR FROM DATE OF PURCHASE. IN NO EVENT SHALL ZODIAC BE LIABLE FOR INCIDENTAL OR CONSEQUENTIAL DAMAGES OF ANY NATURE OR KIND OR FOR DAMAGES TO PERSONS OR PROPERTY, INCLUDING ANY DAMAGE RESULTING FROM THE USE OF THE POLARIS BOOSTER PUMP.

Some states do not allow limitations on how long an implied warranty lasts, or the exclusion or limitation of incidental or consequential damages, so the above limitations may not apply to you.

This limited warranty is valid only in the United States of America and Canada, and it does not apply to Polaris Booster Pumps sold or installed in any other country.

Exploded Parts Diagram

Polaris Halcyon Booster Pump Part #PB4-60Q

No.	Part #	Description	Qty
1	P64	3/4 HP Motor – Seal Plate Assembly	1
2	P85	O-Ring, Seal Plate	1
3	P84	Seal, Ceramic/Spring	1
4	P16	Impeller, 60 HZ	1
5	P82	Volute (Includes Drain Plug with O-Ring)	1
6	P87	Band Clamp	1
7	P88	1/2"-20 UNF Drain Plug with O-ring	1
8	P86	Pump Stand	1
9	P91	1/4-20 x .75" Bolt with washer	2
10	P17	Installation Kit, Softube® Quick Connect	1
11	P19	Pump Hose, 6 Ft, Flexible Reinforced	1
12	P133	Softube® Quick Connect	4
13	P21	Pump Quick Connect Retainer	4

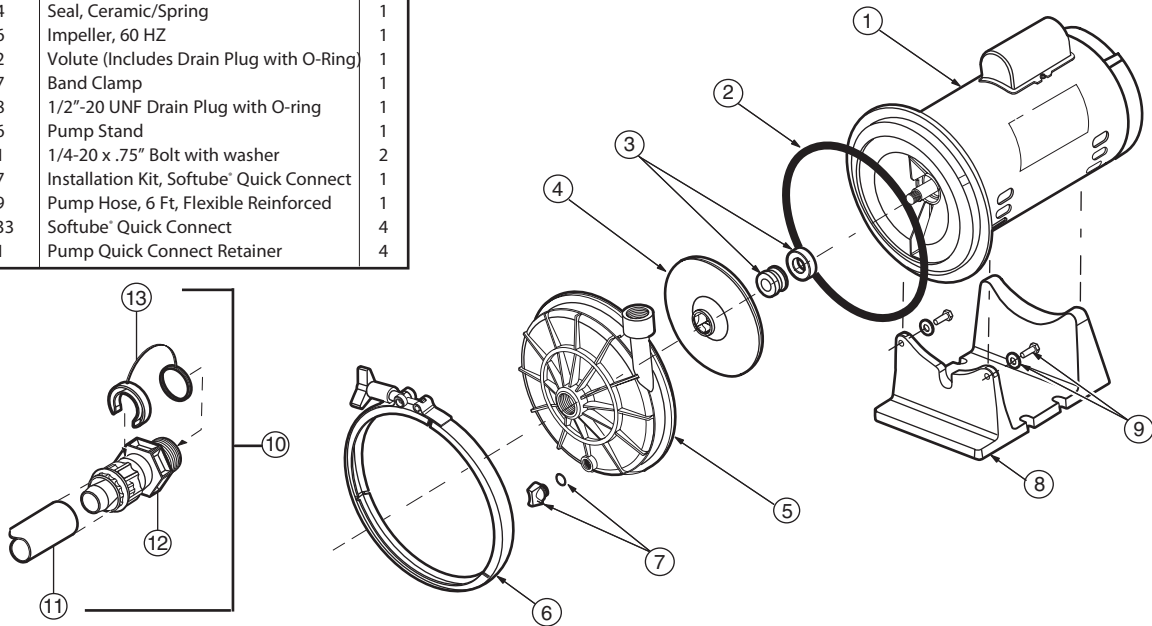

Polaris Booster Pump Part #PB4-60

No.	Part #	Description	Qty
1	P5	Volute (Includes Drain Plug)	1
2	P15	Impeller	1
3	P55	Seal, Stainless Steel Cup/Spring	1
4	P95	O-Ring, Bracket	1
5	P10	Bracket	1
6	P35	Bolt, Stainless, Bracket to Motor	2
7	P40	O-Ring for Shaft	1
8	P61	Motor, 3/4 HP, Threaded Shaft, 60 Hz	1
9	P25	Bolt/Nut, Stainless for Volute to Bracket	6
10	P80	Rubber Strip, Motor/Bracket	1
11	P70	Pump Stand with Feet, Strip	1
12	P75	Rubber Feet	4
13	P65	Bolt, Stainless, Stand to Bracket and Motor	2
14	P20	1/8" NPTM Plug, Plastic	1
15	P17	Installation Kit, Softube® Quick Connect	1
16	P19	Pump Hose, 6 Foot, Flexible Reinforced	1
17	P133	Softube® Quick Connect	4
18	P21	Pump Quick Connect Retainer	4

